

SCG Concrete Roof Tile CPAC Series

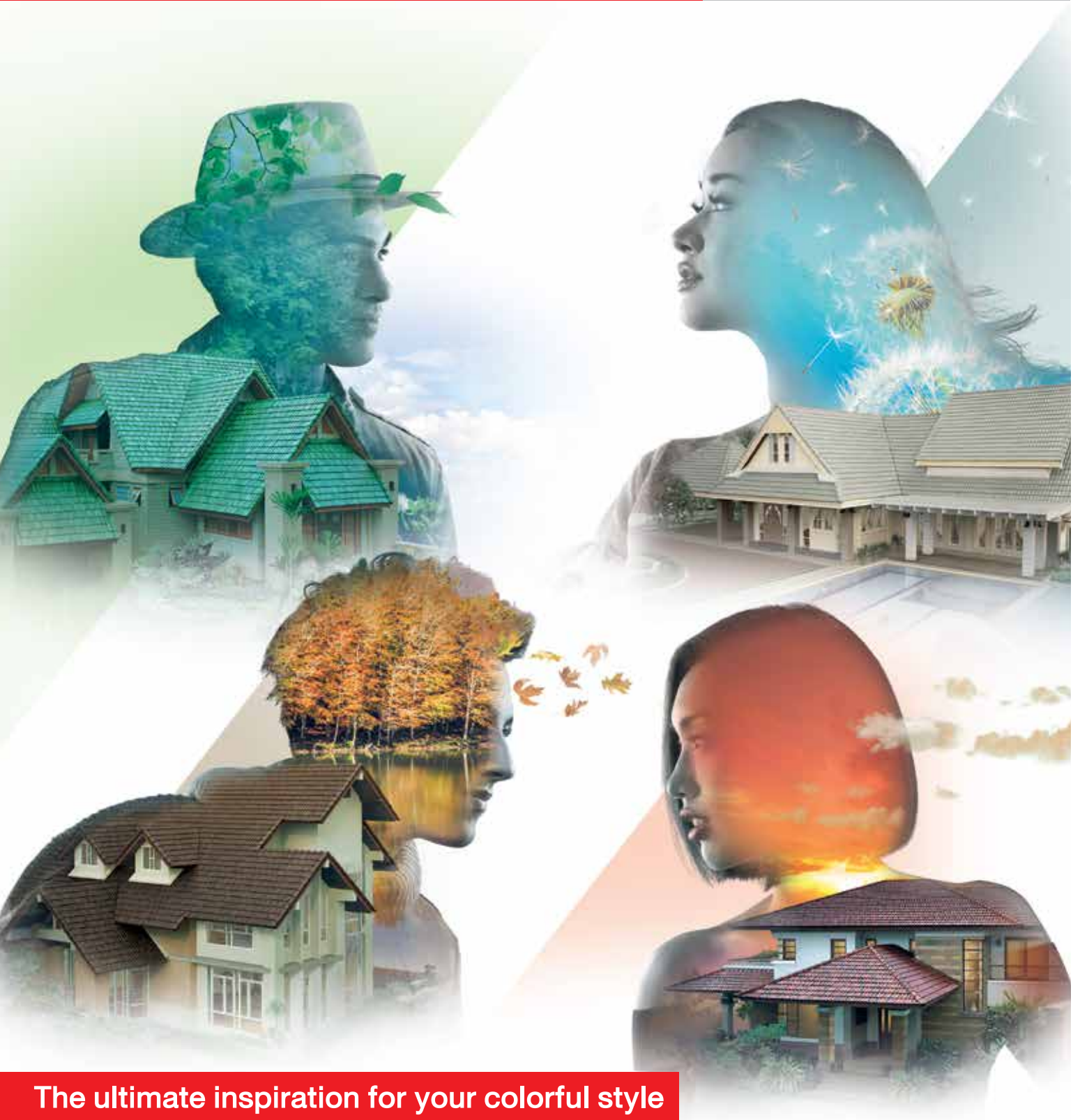
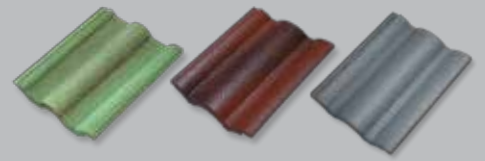

The ultimate inspiration for your colorful style

SCG Concrete Roof Tile CPAC Series

The ultimate roof that lasts long for more than a decade

Beautiful colors and long lasting

By Wet on Wet pigmentation coloring process, ensure for life-long endurance without color peeling or fading.

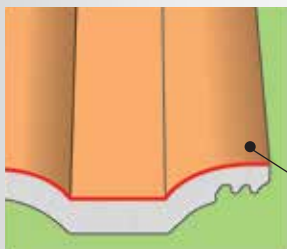

Special coating technique to merge tiles with color molecules

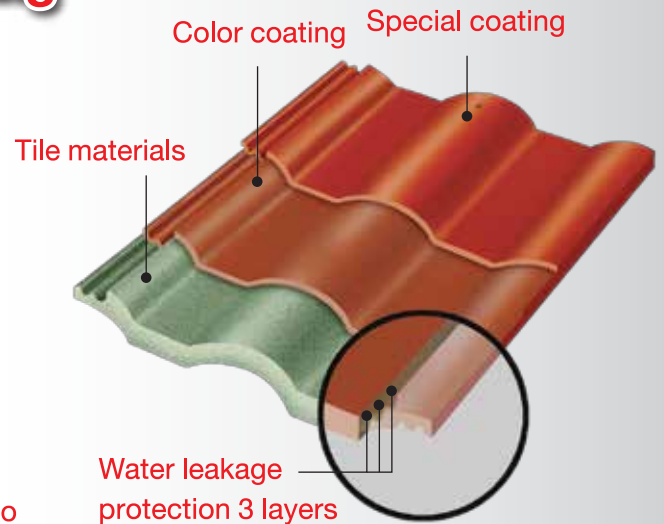

High strength and durability

Produced from SCG high quality of cement with special technology and advance machine, certified by ISO90002 and TIS.535-2540, fully controlled and assured by SCG experts before delivering to customers

Full leakage protection

Superior designed with 3 layers of water leakage protection system throughout all edges to fully prevent water from reversed direction and also sided overlapping design for entirely protection. The product has been tested with wind load and used for more than 40 years

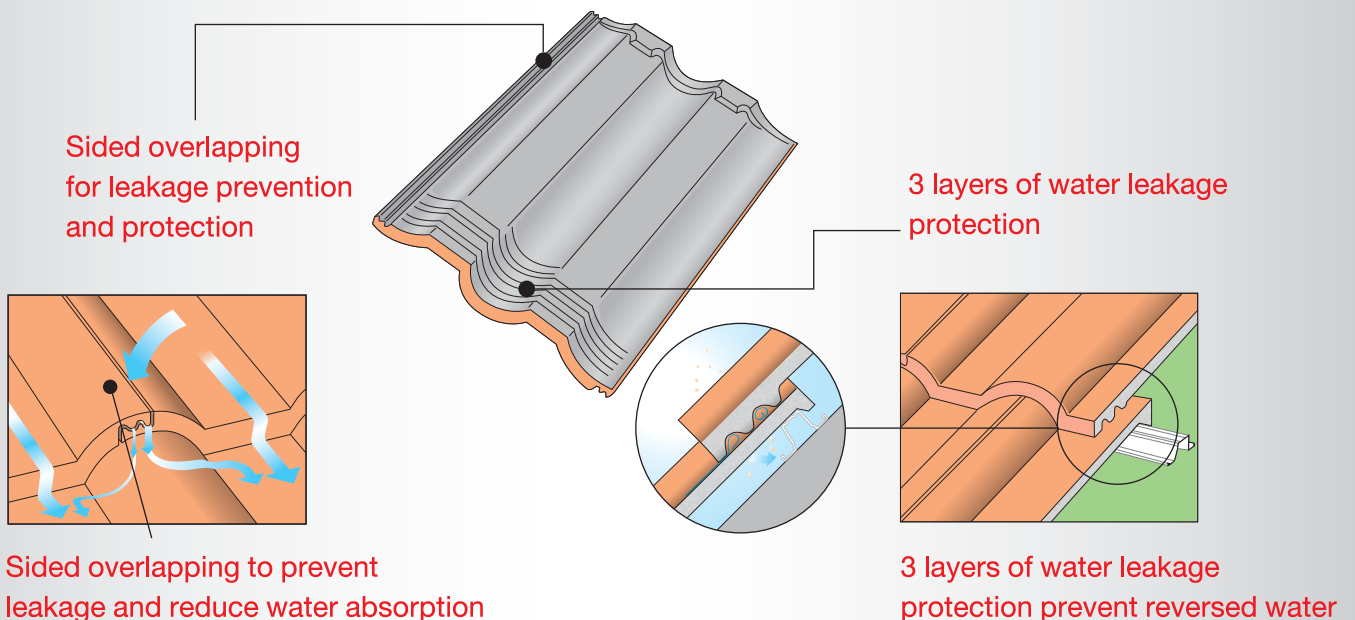

Centurion Series

The gentle, detailed curves reflect the modern style of the house and owners

Centurion

Extravagant yet intricate



Green Field

*



Red

*



Seagull Grey

*

*SCG Concrete Roof, Green Field is certified by "Green Label" because of its solar reflectivity more than standard (NIR > 45%) which reduces heat to houses. Furthermore, the product is certified from its production process that is environmentally concerned, and safe from asbestos.

*Order basis (45-60 days lead time)



*Seagull Grey

Elabana series

The generous curves are pleasing to the eyes and creates a feeling of comfort

Elabana

Harmonious and expansive curve design



Tawny Brick



Myrtle Green

*



Brown Oak



*Tawny Brick

Neo Class series

Show your softer side with pastel colored roof tiles. Jewel toned colors are also available according to your taste

Neo Class

Charm of soft colors

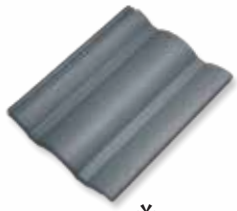

Tantalum Grey

*



Passion Beige

*



Silver Titanium

*



*Silver Titanium

*Order basis (45-60 days lead time)

Contrazz series

Stand out with a perfect combination of unique colored roof tiles that combine different but complementary colors together. Show your imagination with these multicolored tiles that will be different from other tiles

Contrazz

A perfect combination of 2 different shades in your style



Fire Flashed

*

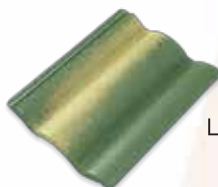

Lunar Flashed

*



Red Flashed

*



Garnet Flashed



Gold Flashed



Bullion Flashed

*



Brown Flashed

*



*Red Flashed

Zeazon

Shades of season



*Summer Clay

Zeazon series

Ideal for compassionate leaders with colors ranging from dark to light, and reflects each season

Summer Clay



*

Autumn Brown



*

Winter Grey



*

*Order basis (45-60 days lead time)

Triple Tone

Inspiration of natural shades



*Green Leaf

Triple Tone series

Nature inspired colors for those who love the splendor of nature

Wood Tone



*

Green Leaf



*

Earth Tone



*

SCG Concrete Roof Fitting, Outstanding throughout the roof



1. Round Ridge

Use along ridge tile and hip ridge area
(Usage 3.3 pcs per 1m)

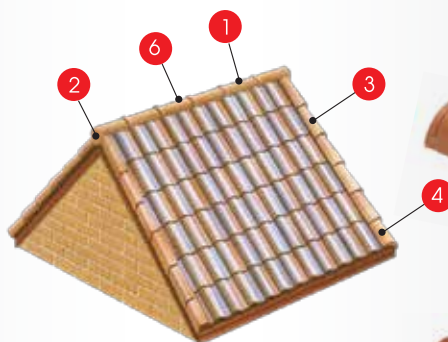

2.Round Ridge End

Cover round ridge for gable roof



3. Barge

Cover gable edge
(Usage 3.3 pcs per 1m)



4. Barge End

Cover gable edge at last ridge end



5.Round Hip End

Close at last ridge end

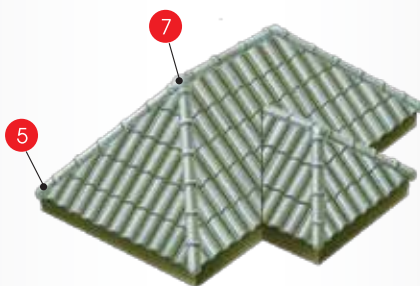

6. 2 Ways Round Apex

Cover at end of round ridge for gable roof



7. 3 Ways Round Apex

Cover at end of round ridge and hip ridge for hip roof design

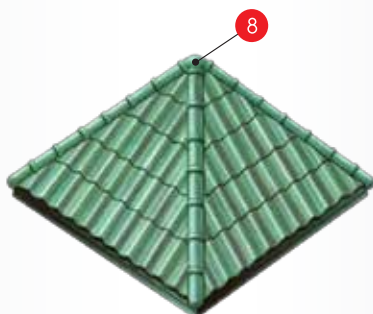

8. 4 Ways Round Apex

Cover hip end from 4 dimensions for hip roof design with square



Product Specification

- Size 33 x 42 cm.
- Weight 4.05 kg./ tile (+/- 0.2kg.)
- Minimum pitch 17 degree (recommended 30-35 degree)
- Usage 10-11 pieces/ Sqm. depends on batten space
- Should purchase tile in the same lot for usage in each time
- Color shades may differ in catalog from actual tile due to printing procedures
- Any details in this catalog could be changed appropriately without prior notification

MHB-S-R22-C009-6101

*The color of the product in the image may be different from the real product color due to the printing system. Please consider the real product color at the shop before purchasing.

All Content, design and layout are Copyright © 2018, SCG Cement-Building Materials All Rights Reserved, Reproduction in whole or part in any form or medium without specific written permission is prohibited.



SCG Marketing Philippines Inc.

Hotline: (02) 717-6900/ T: (02)501-8630/(02)501-8634

Email: scgm@scg.com/ www.scgbuildingmaterials.com

Facebook: [f SCGBrandPhilippines](https://www.facebook.com/SCGBrandPhilippines)